

32 889A12

# Service Manual

## TECHNISCHE GEGEVENS

Voeding	: 220 V/50 Hz met service oplossing voor 110 - 127 - 240 V
Uitgangsvermogen	: FTC, 20-20.000 Hz, $D \leq 0,02\%$ 2x45 W over 8 $\Omega$ IEC, 63-12.500 Hz, $D \leq 0,7\%$ 2x50 W over 8 $\Omega$ DIN45500, 1 kHz, $D \leq 0,7\%$ 2x52 W over 8 $\Omega$
Harmonische vervorming	: $\leq 0,01\%$ bij 45 W over 8 $\Omega$ (1 kHz)
Intermodulatie vervorming 60/7000 Hz 4:1	: $\leq 0,02\%$ bij 45 W
Balans regeling	: 0 - 50 dB
Bas regeling	: +12 tot -12 dB bij 40 Hz
Treble regeling	: +12 tot -11 dB bij 20 kHz
Loudness regeling (Vol $\leq -30$ dB)	: +10 dB bij 40 Hz; +4 dB bij 30 kHz
Ingangsgoedigheid	: Phono 2,5 mV/47 k $\Omega$ Tape 150 mV/47 k $\Omega$ C-Disc 150 mV/47 k $\Omega$ Aux 150 mV/47 k $\Omega$ Tuner 150 mV/47 k $\Omega$
Uitgangen	: Tape 150 mV/2,5 k $\Omega$ 2x2 luidsprekers 8 $\Omega$ koptelefoon 8 - 1000 $\Omega$
Afmetingen (bxhxd)	: 420x73x300 mm

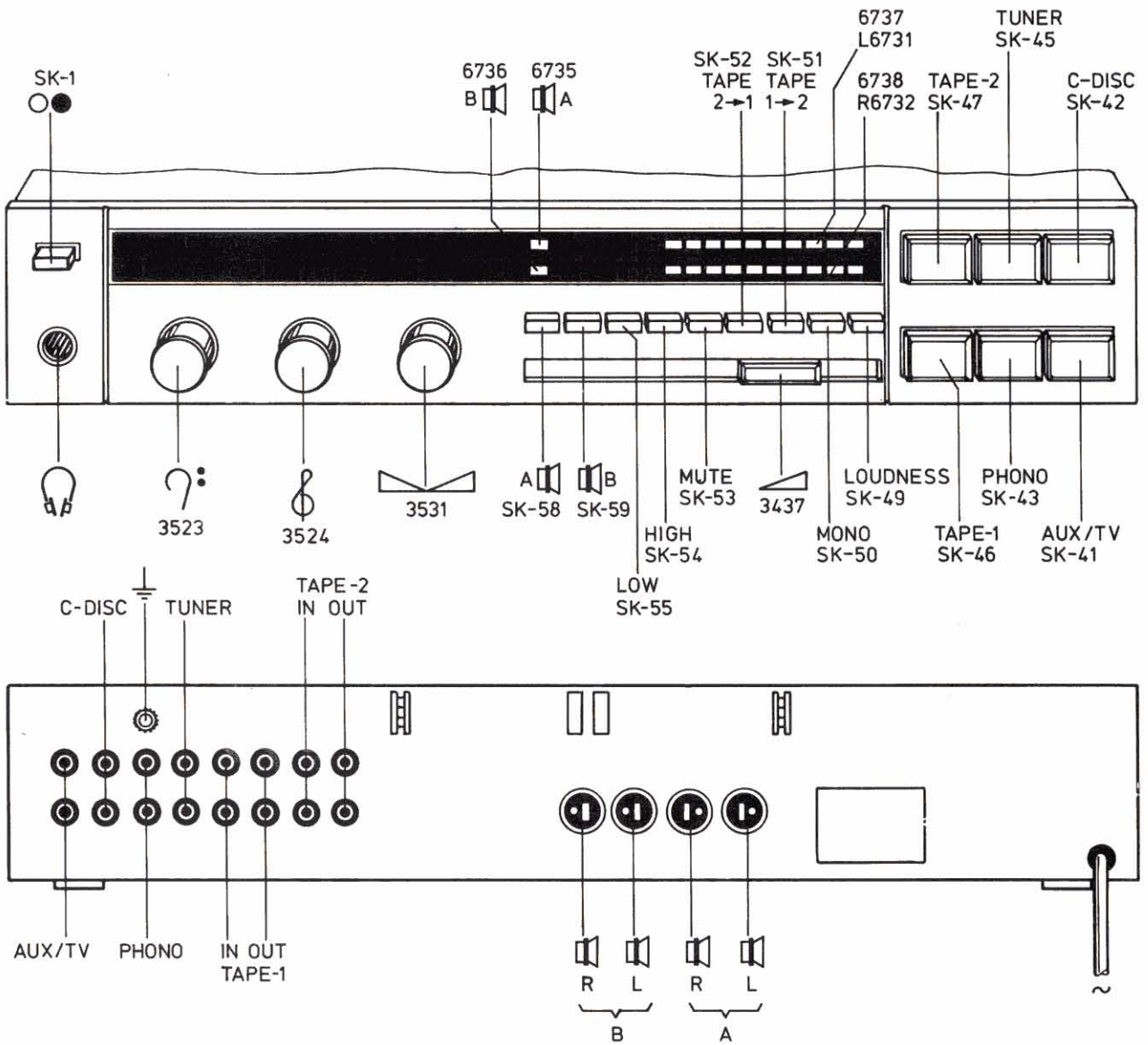

33211 B 13

### Ruststroom instelling

Geen signaal toevoeren.  
 Voor het linker kanaal 3513 afregelen voor 45 mV over 3543.  
 Voor het rechter kanaal 3514 afregelen voor 45 mV over 3544.



### Instellen led power display

De input instellen voor 25 W over  $RL = 8 \Omega$  links en rechts.  
 Potentiometer 3578 zodanig instellen dat de laatste led van het linker- en rechter kanaal met eenzelfde lichtintensiteit brandt.

## CONTROLES LF CIRCUIT

- Alle metingen gebeuren met een testfrequentie van 1 kHz, op speakersysteem A, tenzij anders vermeld.
- Belastingsweerstand van  $8 \Omega$ -80 W-1% over de uitgangen L en R systeem A.
- Stand stereo (SK50).
- Contour schakelaar uit (SK49).
- Tone en balansregelaars in de mechanische middenstand.
- Volume max.
- Stand tape.

## Voeding

SK		+1	ripple	-1	ripple
C-disc SK-42	min.	45 V $\pm 1,5$ V	$\leq 150$ mV rms	-45 V $\pm 1,5$ V	$\leq 100$ mV rms
	 max.	$\geq 35$ V $\pm 1,5$ V	$\leq 1,3$ V rms	$\leq -35$ V $\pm 1,5$ V	$\leq 1,3$ V rms





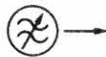



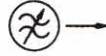

 Signaal toevoeren tot uitgangsvermogen van  $2 \times 45$  W (18,97 V) over belastingsweerstand  $R_L$  en  $R_R$

## Uitgangsvermogen en vervorming\*

SK		F.T.C. $2 \times 45$ W (18,97 V)	IEC $2 \times 50$ W (20 V)	DIN45500 $2 \times 52$ W (20,4 V)
C-disc SK-42	20 Hz	$D \leq 0,02\%$		
	63 Hz		$D \leq 0,7\%$	
	1000 Hz	$D \leq 0,01\%$	$D \leq 0,3\%$	$D \leq 0,7\%$
	12500 Hz		$D \leq 0,7\%$	
	20000 Hz	$D \leq 0,02\%$		

\*Apparaat moet ingekast zijn.

## Toonregeling

SK							 AC
C-disc SK-42	40 Hz	C-disc input	max.	mid position	mid position	 	
				max.		+12 dB $R_L$ ( $R_R$ )	
				min.		-11 dB $R_L$ ( $R_R$ )	
	10 kHz			mid position	mid position	 	
				max.		+10 dB $R_L$ ( $R_R$ )	
				min.		-10 dB $R_L$ ( $R_R$ )	

 Signaal toevoeren tot een uitgangsspanning van 7,75 V (= 0 dB) over belastingsweerstand  $R_L$  en ( $R_R$ ).



### Loudness

SK				Loudn. SK42		AC
C-Disc SK-42	40 Hz		max.	off		0 dB R <sub>L</sub> (R <sub>R</sub> )
				3437		-40 dB R <sub>L</sub> (R <sub>R</sub> )
				on		+10 dB ± 2 dB R <sub>L</sub> (R <sub>R</sub> )
	1000 Hz		max.	off		0 dB R <sub>L</sub> (R <sub>R</sub> )
			3437		-40 dB R <sub>L</sub> (R <sub>R</sub> )	
			on		+1 dB ± 1 dB R <sub>L</sub> (R <sub>R</sub> )	
	10000 Hz		max.	off		0 dB R <sub>L</sub> (R <sub>R</sub> )
			3437		-40 dB R <sub>L</sub> (R <sub>R</sub> )	
			on		+3,5 dB ± 1 dB R <sub>L</sub> (R <sub>R</sub> )	

Volumeregelaar zodanig instellen dat er over de belastingsweerstand R<sub>R</sub> en (R<sub>L</sub>) -40 dB staat.

Signaal toevoeren tot uitgangsvermogen van 2x 45 W (18,97 V) over belastingsweerstand R<sub>L</sub> en R<sub>R</sub>.

### Gevoeligheid

SK			AC
Tape 2 SK46	130-180 mV via 22 kΩ/250 pF	cinch input	18,97 V (2x 45 W)  R <sub>L</sub> (R <sub>R</sub> )
Tape 1 SK45	130-180 mV via 22 kΩ/250 pF		
Phono SK43	2,3-2,8 mV via 2k2 Ω		
Aux/TV SK-41	130-180 mV via 22 kΩ/250 pF		
Tuner SK-44	130-180 mV via 22 kΩ/250 pF		
C-disc SK-42	130-180 mV via 22 kΩ/250 pF		

### PU (MD) Voorversterker

SK				AC
Phono SK43	1000 Hz	Phono input via 2k2		R <sub>L</sub> (R <sub>R</sub> )
	20 Hz 40 Hz 250 Hz 1 kHz 10 kHz 20 kHz			16,3 dB ± 0,7 dB 16,8 dB ± 0,6 dB 6,8 dB ± 0,6 dB 0 dB -13,7 dB ± 0,6 dB -19,6 dB ± 0,6 dB

Signaal toevoeren tot een uitgangsspanning van 7,75 V (= 0 dB) over belastingsweerstand R<sub>L</sub> (R<sub>R</sub>).  
Meet en V gen. en houdt deze constant.



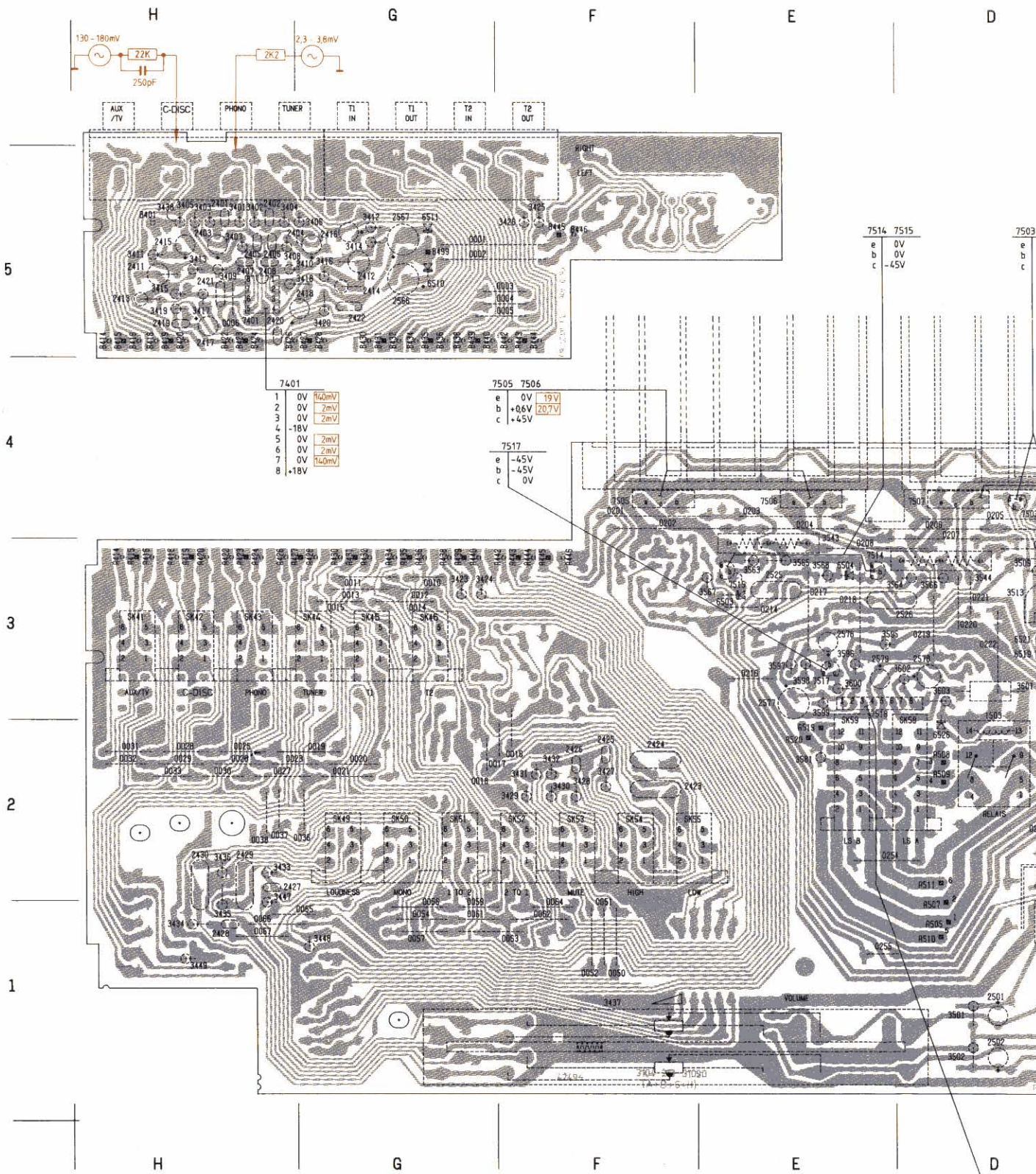

7514	7515	7503
e	0V	e
b	0V	b
c	-45V	c

7401		
1	0V	10mV
2	0V	2mV
3	0V	2mV
4	-18V	
5	0V	2mV
6	0V	2mV
7	0V	10mV
8	+18V	

7505	7506	
e	0V	19V
b	+0.6V	20.7V
c	+45V	

7517	
e	-45V
b	-45V
c	0V

7518	
1	NC
2	0V
3	0V
4	0V
5	0V
6	0V
7	0V
8	4V



D

C

B

A

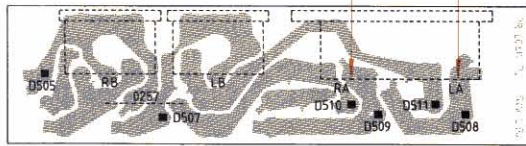

7514	7515
e	0V
b	0V
c	-4.5V

7503	7504
e	-1.2V
b	-0.6V
c	0.5V

7507	7508
e	0V 19V
b	-0.6V 20.7V
c	-4.5V

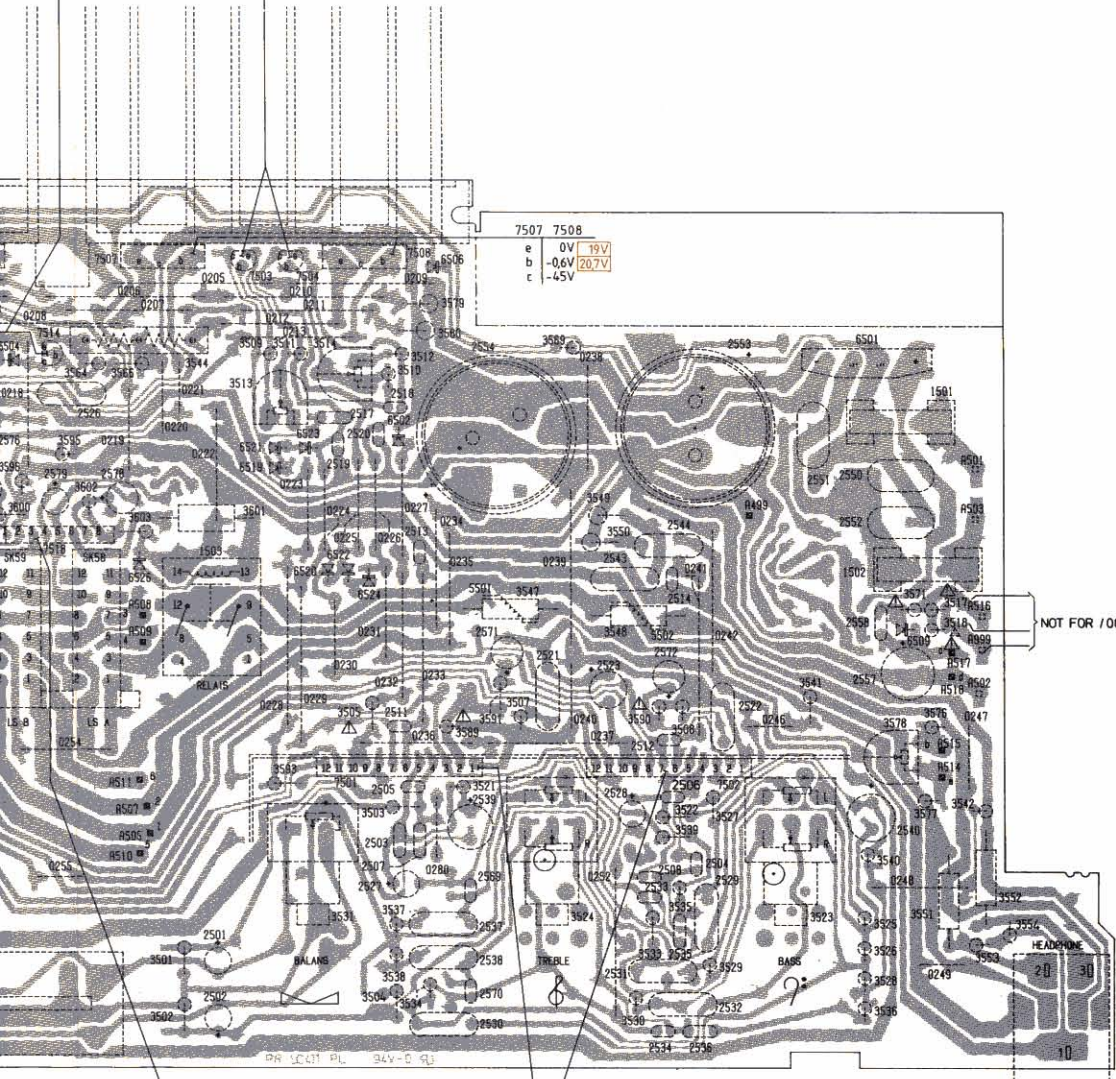

D

C

B

A

7518	
1	NC
2	0V
3	↓
4	0V
5	↓
6	0V/+4.5V
7	0V
8	4V

7501	7502
1	+4.5V
2	+4.5V
3	+3.8V
4	0V 1.25mV
5	0V 1.25mV
6	-4.2V
7	-1.2V
8	+0.5V
9	-4.4V
10	-4.4V
11	-0.6V 20.7V
12	+0.6V 20.7V

5

4

3

2

1





B

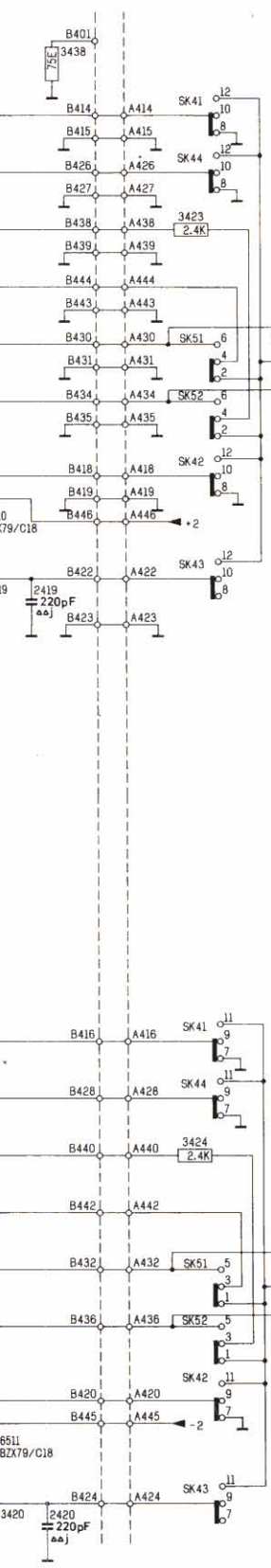

C

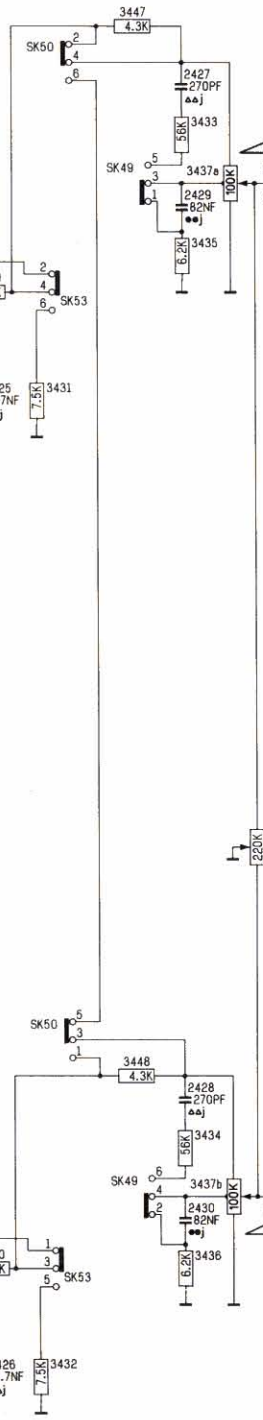

SK	11	12	4X
SK41	AUX/TV		4X
SK42	C-DISC		4X
SK43	PHONO		4X
SK44	TUNER		4X
SK45	TAPE 1		4X
SK46	TAPE 2		4X
SK49	LOUDNESS		2X
SK50	MONO		2X
SK51	T1 → T2		2X
SK52	T2 → T1		2X
SK53	MUTE		2X
SK54	HIGH		2X
SK55	LOW		2X
SK58	SPEAKERS A		4X
SK59	SPEAKERS B		4X

D

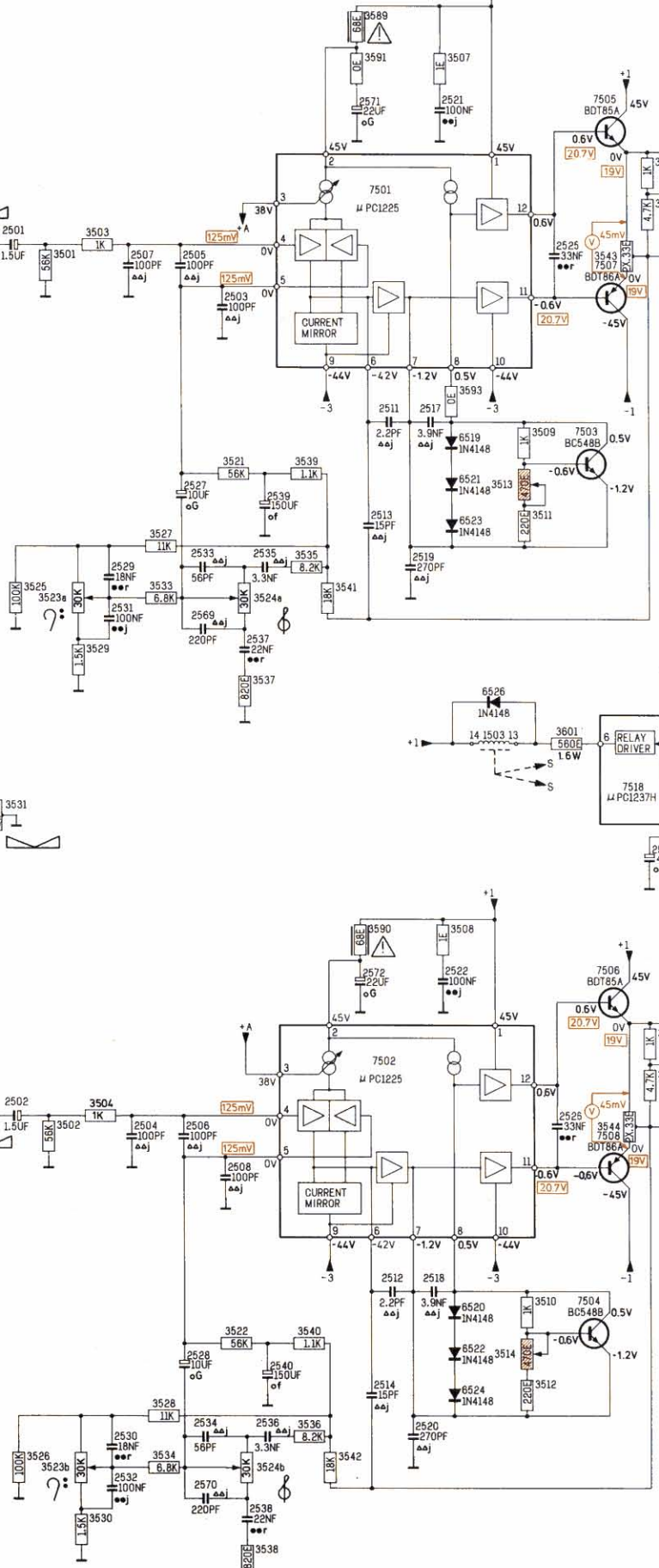

E

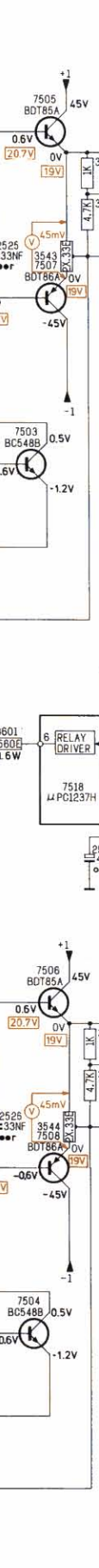

B

C

D

E



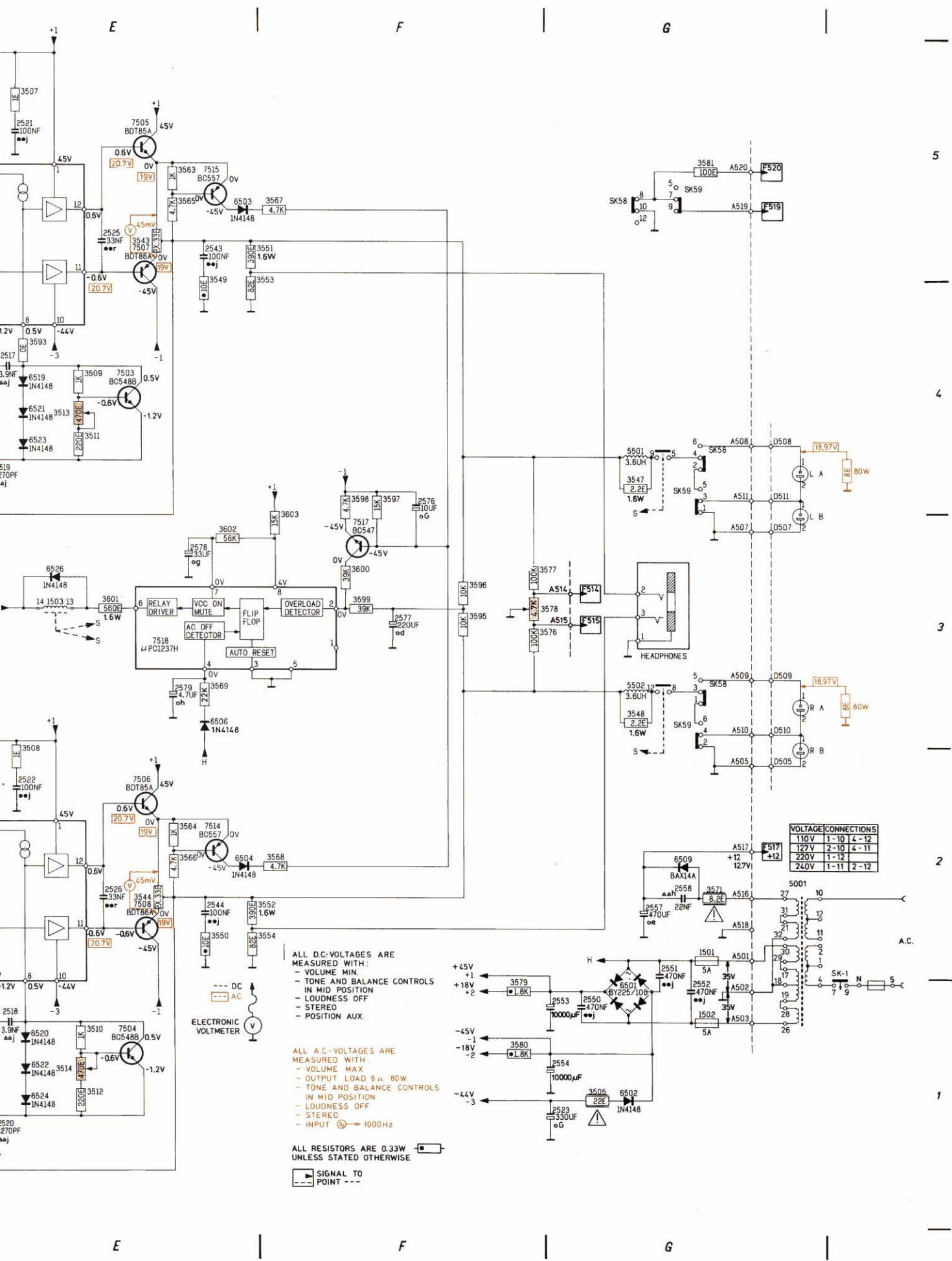

ALL D.C. VOLTAGES ARE MEASURED WITH:  
 - VOLUME MIN.  
 - TONE AND BALANCE CONTROLS IN MID POSITION  
 - LOUDNESS OFF  
 - STEREO  
 - POSITION AUX.

ALL A.C. VOLTAGES ARE MEASURED WITH:  
 - OUTPUT LOAD 8 Ω 80W  
 - TONE AND BALANCE CONTROLS IN MID POSITION  
 - LOUDNESS OFF  
 - STEREO  
 - INPUT 1000 Hz

ALL RESISTORS ARE 0.33W UNLESS STATED OTHERWISE

—●— SIGNAL TO POINT

VOLTAGE CONNECTIONS		
110V	1-10	4-12
127V	2-10	4-11
220V	1-12	
240V	1-11	2-12

5  
4  
3  
2  
1

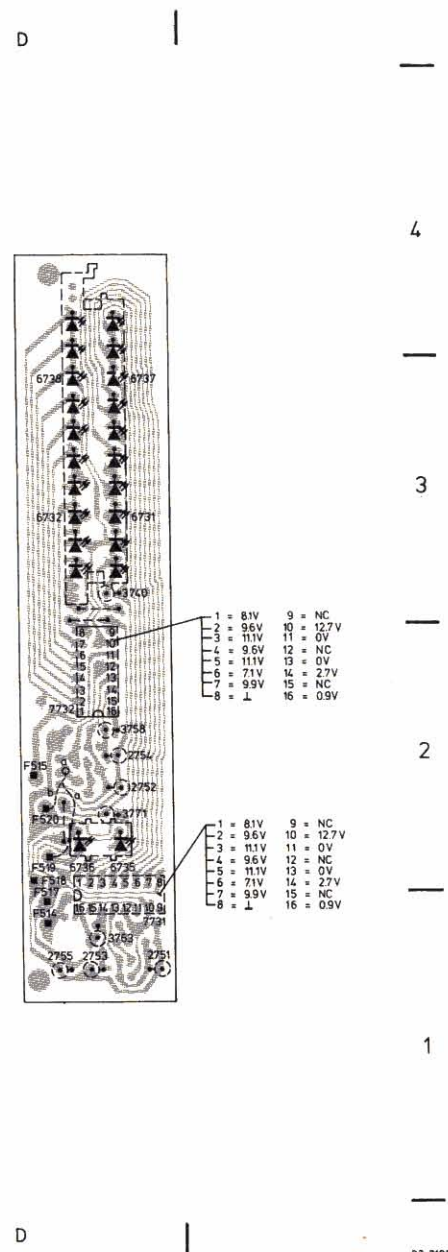
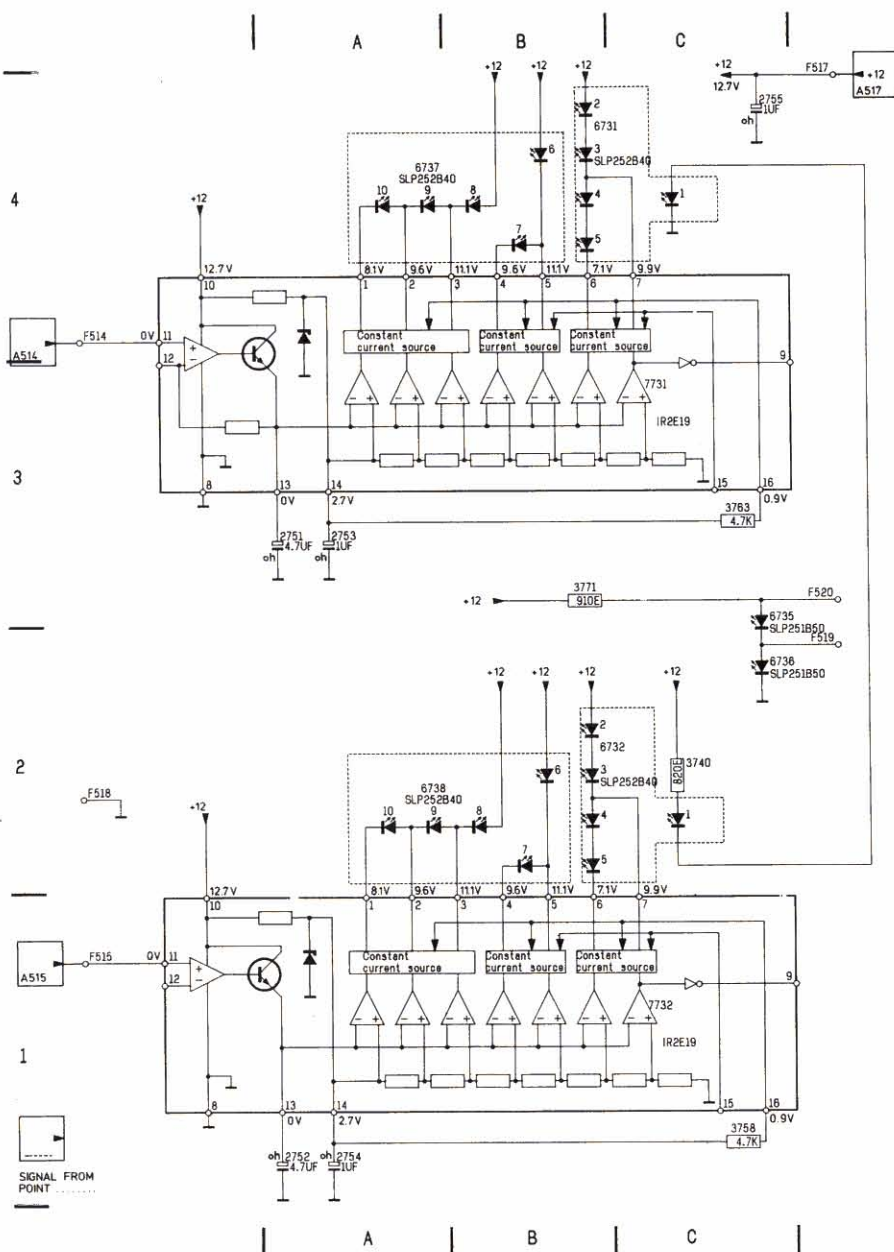

DISPLAY

ITEM	CD	PCB									
2751	A03	D01	3740	C02	D03	6732	B02	D03	7731	C03	D02
2752	A01	D02	3758	C01	D02	6735	C03	D02	7732	C01	D03
2753	A03	D01	3763	C03	D02	6736	C02	D02			
2754	A01	D02	3771	B03	D02	6737	A04	D04			
2755	C04	D01	6731	B04	D03	6738	A02	D04			







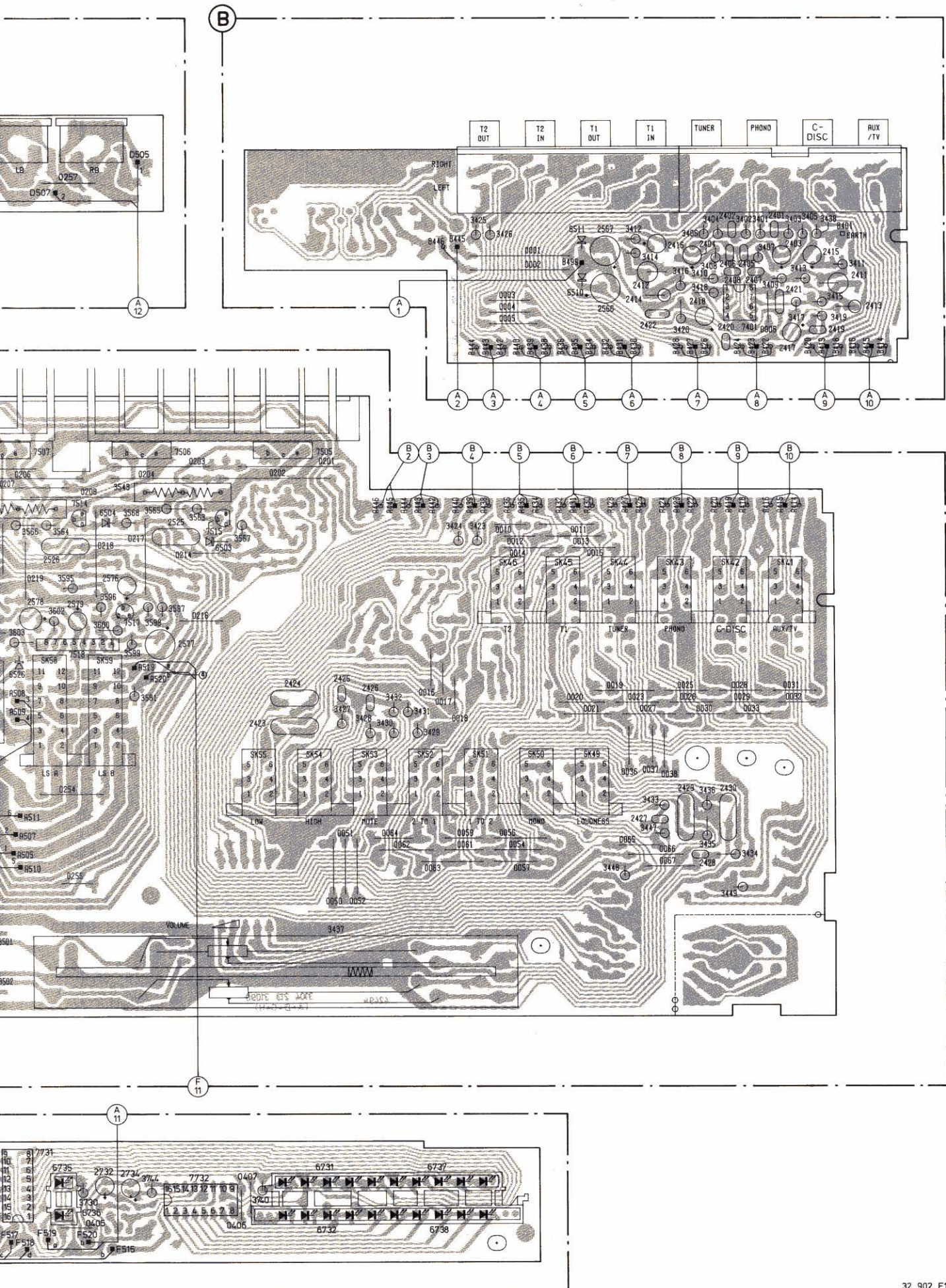



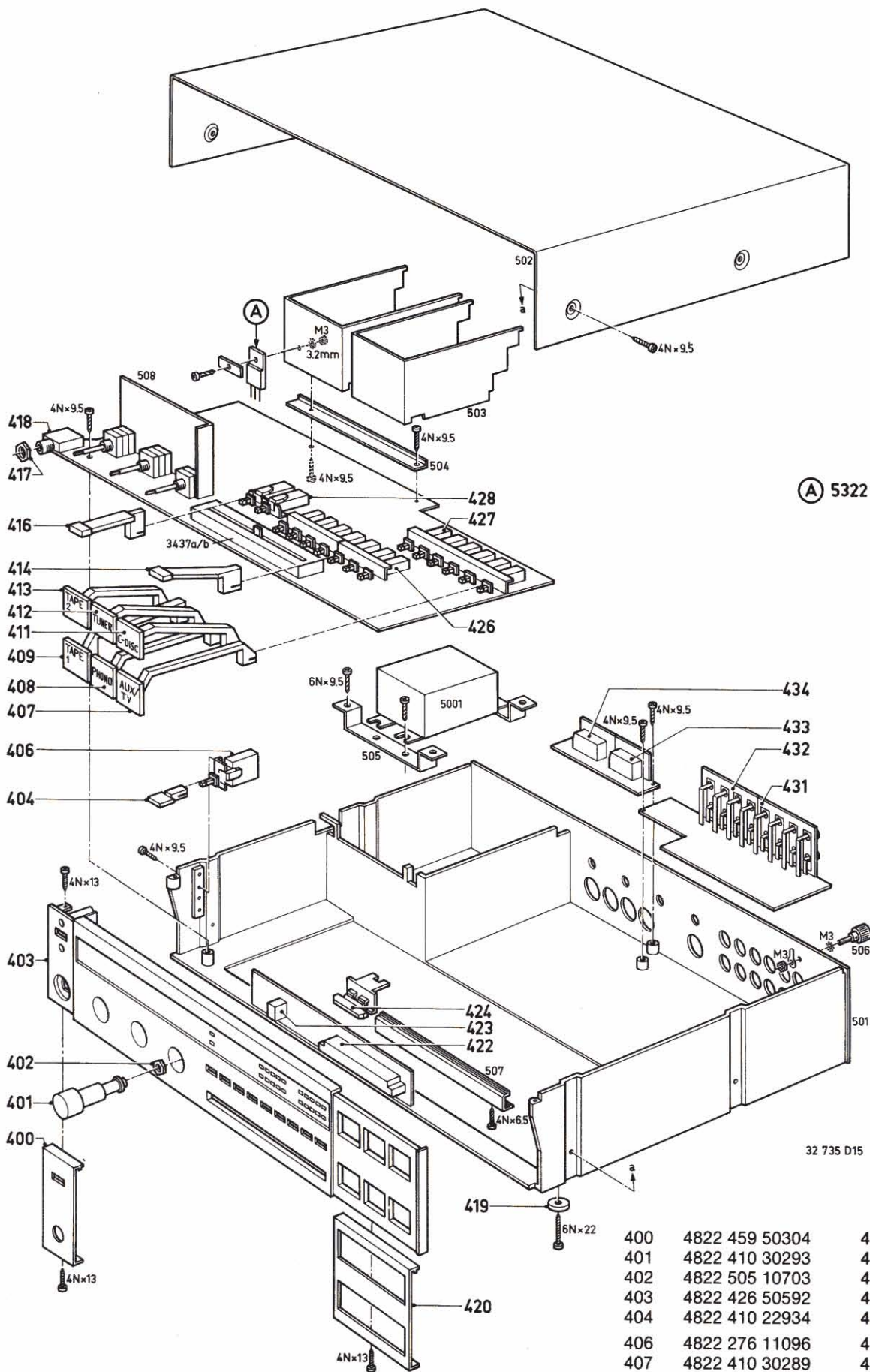

(A) 5322 390 20019

32 735 D15

400	4822 459 50304	418	4822 267 30324
401	4822 410 30293	419	4822 462 40409
402	4822 505 10703	420	4822 426 50653
403	4822 426 50592	422	4822 256 90495
404	4822 410 22934	423	4822 256 90496
406	4822 276 11096	424	4822 411 60937
407	4822 410 30289	426	4822 276 11099
408	4822 410 30291	427	4822 276 11102
409	4822 410 30286	428	4822 276 20291
411	4822 410 23048	431	4822 267 50284
412	4822 410 30288	432	4822 267 50284
413	4822 410 30287	433	4822 267 30377
414	4822 410 30284	434	4822 267 30377
416	4822 410 30285		
417	4822 505 10571		

